

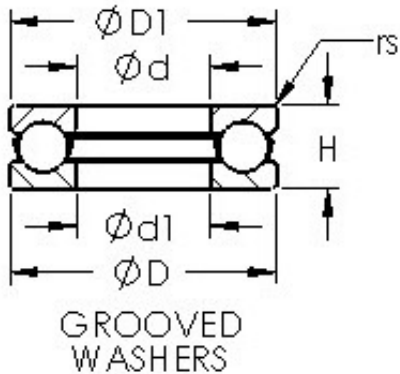

ISO BEARING-SINGAPORE (PTE)LTD.



AST 51120M thrust ball bearings

Bearing No. 51120M

Bore Diameter	100 mm
Outer Diameter	135 mm
Bearing Type	with grooved raceway(s)
Bore Dia (d)	100.0000
Outer Dia (D)	135.0000
Radius (min) (rs)	1.000
Static Load Rating (Cor)	239,000
Dynamic Load Rating (Cr)	77,100
Max Speed (Grease) (X1000 RPM)	2
Max Speed (Oil) (X1000 RPM)	2
Height (H)	25.0000
Outer Dia. Pilot (D1)	135.0000
Bore Dia. Clearance (d1)	102.0000
Weight (g)	1,114.00
Material	52100 chrome steel, or equivalent.

51120M Bearing 2D drawings and 3D CAD models